



DS-1200KI/DS-1006KI Keyboard

User Manual

User Manual

About this Manual

The Manual includes instructions for using and managing the product. Pictures, charts, images and all other information hereinafter are for description and explanation only. The information contained in the Manual is subject to change, without notice, due to firmware updates or other reasons. Please find the latest version in the company website.

Please use this user manual under the guidance of professionals.

Legal Disclaimer

TO THE MAXIMUM EXTENT PERMITTED BY APPLICABLE LAW, THE PRODUCT DESCRIBED, WITH ITS HARDWARE, SOFTWARE AND FIRMWARE, IS PROVIDED "AS IS", WITH ALL FAULTS AND ERRORS, AND OUR COMPANY MAKES NO WARRANTIES, EXPRESS OR IMPLIED, INCLUDING WITHOUT LIMITATION, MERCHANTABILITY, SATISFACTORY QUALITY, FITNESS FOR A PARTICULAR PURPOSE, AND NON-INFRINGEMENT OF THIRD PARTY. IN NO EVENT WILL OUR COMPANY, ITS DIRECTORS, OFFICERS, EMPLOYEES, OR AGENTS BE LIABLE TO YOU FOR ANY SPECIAL, CONSEQUENTIAL, INCIDENTAL, OR INDIRECT DAMAGES, INCLUDING, AMONG OTHERS, DAMAGES FOR LOSS OF BUSINESS PROFITS, BUSINESS INTERRUPTION, OR LOSS OF DATA OR DOCUMENTATION, IN CONNECTION WITH THE USE OF THIS PRODUCT, EVEN IF OUR COMPANY HAS BEEN ADVISED OF THE POSSIBILITY OF SUCH DAMAGES.

REGARDING TO THE PRODUCT WITH INTERNET ACCESS, THE USE OF PRODUCT SHALL BE WHOLLY AT YOUR OWN RISKS. OUR COMPANY SHALL NOT TAKE ANY RESPONSIBILITIES FOR ABNORMAL OPERATION, PRIVACY LEAKAGE OR OTHER DAMAGES RESULTING FROM CYBER ATTACK, HACKER ATTACK, VIRUS INSPECTION, OR OTHER INTERNET SECURITY RISKS; HOWEVER, OUR COMPANY WILL PROVIDE TIMELY TECHNICAL SUPPORT IF REQUIRED.

SURVEILLANCE LAWS VARY BY JURISDICTION. PLEASE CHECK ALL RELEVANT LAWS IN YOUR JURISDICTION BEFORE USING THIS PRODUCT IN ORDER TO ENSURE THAT YOUR USE CONFORMS THE APPLICABLE LAW. OUR COMPANY SHALL NOT BE LIABLE IN THE EVENT THAT THIS PRODUCT IS USED WITH ILLEGITIMATE PURPOSES.

IN THE EVENT OF ANY CONFLICTS BETWEEN THIS MANUAL AND THE APPLICABLE LAW, THE LATER PREVAILS.

Regulatory Information

FCC Information

Please take attention that changes or modification not expressly approved by the party responsible for compliance could void the user's authority to operate the equipment.

FCC compliance: This equipment has been tested and found to comply with the limits for a Class A digital device, pursuant to part 15 of the FCC Rules. These limits are designed to provide reasonable protection against harmful interference when the equipment is operated in a commercial environment. This equipment generates, uses, and can radiate radio frequency energy and, if not installed and used in accordance with the instruction manual, may cause harmful interference to radio communications. Operation of this equipment in a residential area is likely to cause harmful interference in which case the user will be required to correct the interference at his own expense.

FCC Conditions

This device complies with part 15 of the FCC Rules. Operation is subject to the following two conditions:

1. This device may not cause harmful interference.
2. This device must accept any interference received, including interference that may cause undesired operation.

EU Conformity Statement

 This product and - if applicable - the supplied accessories too are marked with "CE" and comply therefore with the applicable harmonized European standards listed under the EMC Directive 2014/30/EU, the LVD Directive 2014/35/EU, the RoHS Directive 2011/65/EU.

 2012/19/EU (WEEE directive): Products marked with this symbol cannot be disposed of as unsorted municipal waste in the European Union. For proper recycling, return this product to your local supplier upon the purchase of equivalent new equipment, or dispose of it at designated collection points. For more information see: www.recyclethis.info

 2006/66/EC (battery directive): This product contains a battery that cannot be disposed of as unsorted municipal waste in the European Union. See the product documentation for specific battery information. The battery is marked with this symbol, which may include lettering to indicate cadmium (Cd), lead (Pb), or mercury (Hg). For proper recycling, return the battery to your supplier or to a designated collection point. For more information see: www.recyclethis.info

Industry Canada ICES-003 Compliance



This device meets the CAN ICES-3 (A)/NMB-3(A) standards requirements.

Applicable Models

This manual is applicable to DS-1200KI and DS-1006KI keyboard models.

Symbol Conventions

The symbols that may be found in this document are defined as follows.

Symbol	Description
 NOTE	Provides additional information to emphasize or supplement important points of the main text.
 WARNING	Indicates a potentially hazardous situation, which if not avoided, could result in equipment damage, data loss, performance degradation, or unexpected results.
 DANGER	Indicates a hazard with a high level of risk, which if not avoided, will result in death or serious injury.

Safety Instructions

- Proper configuration of all passwords and other security settings is the responsibility of the installer and/or end-user.
- In the use of the product, you must be in strict compliance with the electrical safety regulations of the nation and region. Please refer to technical specifications for detailed information.
- Input voltage should meet both the SELV (Safety Extra Low Voltage) and the Limited Power Source with 12 VDC according to the IEC60950-1 standard. Please refer to technical specifications for detailed information.
- Do not connect several devices to one power adapter as adapter overload may cause overheating or a fire hazard.
- Please make sure that the plug is firmly connected to the power socket.
- If smoke, odor or noise rise from the device, turn off the power at once and unplug the power cable, and then please contact the service center.

Preventive and Cautionary Tips

Before connecting and operating your device, be advised of the following tips:

- Ensure unit is installed in a well-ventilated, dust-free environment.
- Unit is designed for indoor use only.

- Keep all liquids away from the device.
- Ensure environmental conditions meet factory specifications.
- Ensure unit is properly secured to a rack or shelf. Major shocks or jolts to the unit as a result of dropping it may cause damage to the sensitive electronics within the unit.
- Use the device in conjunction with an UPS if possible.
- Power down the unit before connecting and disconnecting accessories and peripherals.
- Improper use or replacement of the battery may result in explosion. Replace with the same or equivalent type only. Dispose of used batteries according to the instructions provided by the battery manufacturer.

TABLE OF CONTENTS

Chapter 1 Overview	1
1.1 Introduction	1
1.2 Features.....	1
1.3 Appearance	1
1.4 Interfaces and Buttons	2
1.5 Functional Buttons	3
Chapter 2 Getting Started	7
2.1 Activate Your Device.....	7
2.2 Login	7
2.3 System Menu.....	9
Chapter 3 Web Configuration	10
3.1 Device Mangement	10
3.1.1 Add Devices.....	10
3.1.2 Manage Input/Output Channels	11
3.2 User and User-related Device Management.....	13
Chapter 4 Keyboard Operation.....	15
4.1 Keyboard Operation	16
4.1.1 Video Wall Control	16
4.1.2 Call Presets/Patrols/Patterns	17
4.1.3 Call Scenes.....	18
4.2 MAG by IP.....	18
4.3 DVR by IP	19
4.4 MAG by RS-422	20
4.5 DVR by RS-485	22
4.6 To Analog Device	23
4.6.1 Dome by RS-485	23
4.6.2 Analog Matrix by RS-232	24
4.7 iVMS and Third-Party Platform	25
4.7.1 Access iVMS Platform by Network.....	25
4.7.2 Access Third-Party Platform by Network	25
4.8 Shortcut Operation	26
Chapter 5 System Menu Configuration	27

5.1 Version.....	27
5.2 User Management	27
5.3 Serial Port Settings	27
5.4 Hardware.....	28
5.5 Time Settings.....	28
5.6 Maintenance	29
Chapter 6 Specifications	30

Chapter 1 Overview

1.1 Introduction

DS-1200KI and DS-1006KI series products are new generation and cost effective control keyboards. The keyboards work well with a large variety of devices, such as network cameras, speed domes, DVRs and NVRs, decoders, multi-functional video centers (MVCs), video wall controllers, and matrix access gateways (MAGs). Featuring a 4-axis Hall effect joystick, a 128 × 64 dot-matrix screen, easy-to-operate press keys, our products are a perfect solution for medium and small sized monitor centers in industries such as intelligent building, transportation, and public security.

In this manual, both Web configuration and keyboard operation sections apply to DS-1200KI network keyboards, while only the keyboard operation section applies to DS-1006KI serial keyboards.

1.2 Features

- 128 × 64 screen
- 4-axis joystick
- Accessible to the multi-functional video centers (MVCs), matrix access gateways (MAGs), video wall controllers, decoders, and shortcut operation of camera/camera groups switch on video wall
- Connectable to domes and realize PTZ control and picture capture via joystick operation
- Accessible to DVRs/NVRs (with KB ports) via network or serial ports, and operation of front panel buttons
- 16 user accounts management: 1 admin and 15 operators
- System upgrade and import/export of configuration files via USB-flash disk
- DS-1200KI keyboard supports both network and serial communication; DS-1006KI supports serial communication only
- DS-1200KI keyboard: network access, configuration, and batch import of devices and input channels via Web browser; up to 1000 devices, 2000 input channels, and 256 output channels can be managed in the keyboard operation mode
- DS-1006KI keyboard: accessible to devices via RS-485/422 serial ports

1.3 Appearance

Except for the network port, DS-1200KI keyboards are the same as DS-1006KI keyboards in appearance. See Figure 1-1 for the appearance of the keyboard.



Figure 1-1 Keyboard Appearance

1.4 Interfaces and Buttons

See Figure 1-2 for the interfaces and joystick of the keyboard.



Figure 1-2 Interfaces

See Figure 1-2 for the interfaces and joystick of the keyboard.

Table 1-1 Description of Rear Panel

SN	Item	Description
1	4-axis joystick	<ul style="list-style-type: none"> In menu mode, <ul style="list-style-type: none"> Move to up/down to select the menu for configuration Move to left/right to select items in menu. When entering the value in the field, move to the left to clear the previous character. Press the central button to confirm. In shortcut operation mode, <ul style="list-style-type: none"> Move the joystick to realize pan/tilt movement in 8

		<p>directions. And the PTZ speed is depending on the joystick movement range.</p> <p>Rotate the joystick in clockwise/anti-clockwise directions to realize the zoom in/out control.</p> <p>Press the central button to capture picture.</p> <ul style="list-style-type: none"> ● In DVR operation mode, <p>In preview mode, move to up/down or left/right to switch between screens (previous/next).</p> <p>In playback mode, move up/down to speed up or slow down playback videos at a normal speed.</p>
2	Network port (for DS-1200KI only)	10/100 Mbps Ethernet interface
3	RS-232 serial interface	Connecting with analog matrixs
4	USB interface	Universal Serial Bus (USB) port for additional devices such as USB-flash disk
5	RS-422 serial interface	Connect with MAGs
	RS-485 serial interface	Connect with DVRs/NVRs or analog speed domes
6	Power supply	12 VDC power input

1.5 Functional Buttons

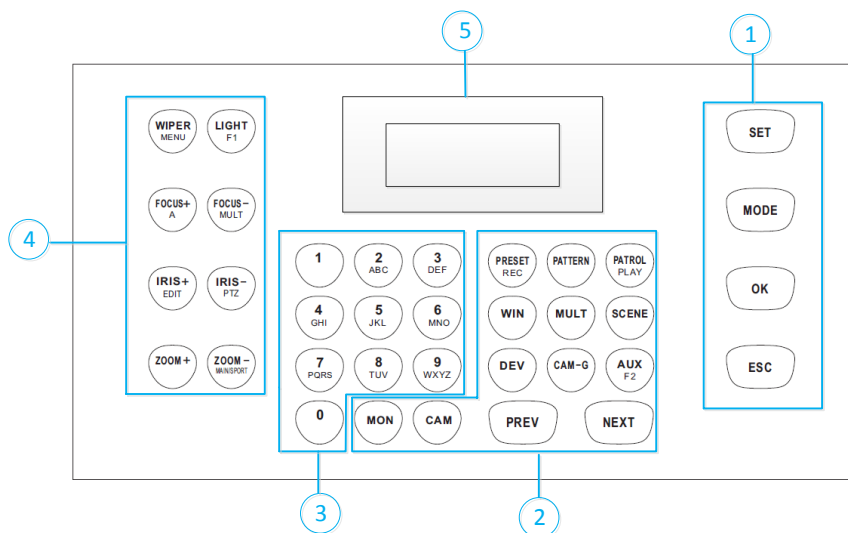



Figure 1-3 Functional Buttons

Buttons on the front panel are used to control PTZ functions of cameras, video wall operations, and local keyboard menu operations. See Table 1-2 for the description of each button. When your

keyboard is connected to DVR/NVR, the keyboard can be used to call the device menu and realize PTZ control through the virtual panel. For remote device menu operations, see 0 for the description of each button.

Table 1-2 Description of Buttons for Keyboard Operation

SN	Item	Button	Description
1	Common Buttons	SET	Enter the main menu of the system.
		MODE	Enter the 6 operation modes interface.
		OK	Confirm the menu item selection and operation.
		ESC	Cancel and back to the pervious menu.
2	Video Wall Control	MON	Use with the numeric buttons to select the monitor.
		CAM	Use with the numeric buttons to select the camera.
		RRESET/REC	Use with the numeric buttons to call the preset.
		PATTERN	<ul style="list-style-type: none"> Press <i>PATTERN</i> directly or <i>0 + PATTERN</i> to call the auto scanning. Use with the numeric (> 0) buttons to call the pattern.
		PATROL/PLAY	Use with the numeric buttons to call the patrol.
		WIN	Use with the numeric buttons to select window of video wall.
		MULT	Use with the numeric buttons to select the window division modes of video wall.
		SCENE	Use with the numeric buttons to switch the scenes.
		DEV	Use with the numeric buttons to select the device ID.  NOTE As IPCs and network speed domes do not have device IDs but channel IDs, use CAM IDs instead when selecting the devices.
		CAM-G	Use with the numeric buttons to select the camera group.
Wall/AUX	<ul style="list-style-type: none"> Use with the numeric buttons to select the video wall ID or joint screen ID. In iVMS Platform operation mode, obtain the video wall or scene list, and use with the numeric buttons to select a video wall or scene. 		

		PREV	In the shortcut operation mode, switch to the previous camera ID or camera group ID.
		NEXT	In the shortcut operation mode, switch to the next camera ID or camera group ID.
3	Alphanumeric Buttons	0-9/A-Z	Inputs numbers and characters in edit mode.
4	PTZ Control	WIPER/ MENU	In PTZ control mode, turn on/off the wiper.
		LIGHT/F1	In PTZ control mode, turn on/off the light.
		FOCUS+/A	<ul style="list-style-type: none"> ● In PTZ control mode, operate the focus far. ● In edit mode, switch the character input mode: numerals (123), upper case (ABC) and lower case (abc).
		FOCUS- /MULT	In PTZ control mode, operate the focus near.
		IRIS+/EDIT	In PTZ control mode, operate the iris open.
		IRIS-/PTZ	In PTZ control mode, operate the iris close.
		ZOOM+	In PTZ control mode, operate the zoom in.
		ZOOM- MAIN/SPOT	In PTZ control mode, operate the zoom out.
5	LCD Display		128 × 64 pixel screen for display of menu.

Table 1-3 Description of Buttons for Controlling DVR/NVR

SN	Item	Button	Description
1	Common Buttons	OK	Confirm the selection and operation. In preview mode, start or stop previewing when the switch time is not set as 0.
		ESC	Exit the PTZ mode. Return to the previous menu.
2	Playback Control	RRESET/REC	In preview mode, enable or disable all-day scheduled recording for all channels.
		PATROL/PLAY	In preview mode, open the playback mode. In playback mode, select entry and exit date and time.
		WALL/AUX	Switch between playback modes
3	Alphanumeric Buttons	0-9	In edit mode, input digits. In preview mode, switch between preview channels. In playback mode, switch between playback channels.
4	DVR Control	WIPER/MENU	In preview mode, focus on the Preview button in the navigation bar; in other modes, go to the preview interface. Select all the list on the main menu.
		LIGHT/F1	In playback mode, forward or playback the recording files In preview mode, instantly start playing back recordings of the last 5 minutes.
		FOCUS+/A	In edit mode, switch the character input mode: numerals (123), upper case (ABC) and lower case (abc).
		FOCUS-/MULT	In preview and playback mode, divide the screen.
		IRIS+/EDIT	Go to the edit mode. In edit mode, delete characters before the cursor. Select checkboxes.
		IRIS-/PTZ	In preview mode, go to the PTZ mode.
		ZOOM-/MAIN/SPOT	Switch between the main and auxiliary interface.

Chapter 2 Getting Started

2.1 Activate Your Device

Purpose:

For the first-time access, you need to activate the device by setting an admin password. No operation is allowed before activation. You can also activate the device via SADP as well.

Step 1 In the Device Activation interface, enter the admin password in the text field of **Admin Password** and **Confirm**.



NOTE

In edit mode, you can press the FOCUS+/A button on the keyboard panel to switch the character input mode: numerals (123), upper case (ABC) and lower case (abc).

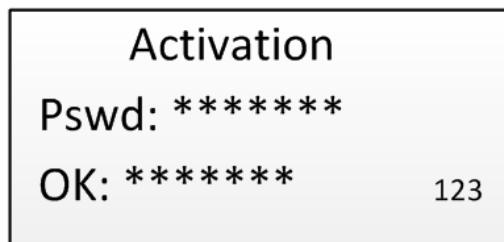

Figure 2-1 Activation Interface



WARNING

STRONG PASSWORD RECOMMENDED—We highly recommend that you create a strong password of your own choosing (8 characters, including upper case letters, lower case letters, numbers, and special characters) in order to increase the security of your product. And we recommend that you reset your password regularly, especially in the high security system, resetting the password monthly or weekly can better protect your product.

Step 2 Click **Confirm** to finish the device activation.



NOTE

- After the device is activated, you need to adjust the date and time settings.
- If you have restored the device to default settings, you need to reactivate the device.

2.2 Login

Purpose:

You must log in to the device before configuring the keyboard, and operating the menu and other functions. DS-1200KI keyboards support two ways of login: local login and remote login (by Web browser). DS-1006KI keyboards support local login only.

Local Login

Step 1 In the Login interface, enter the user name in the User Name field.

Step 2 Enter the password in the Password field.

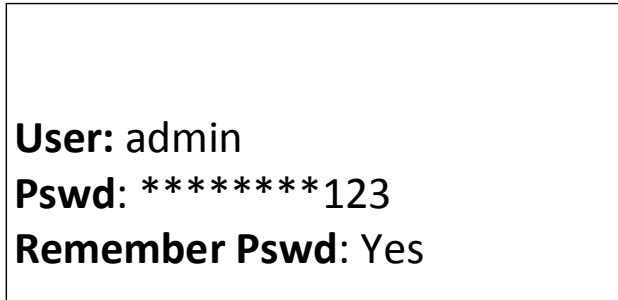

Figure 2-2 Login Interface

Step 3 Press the **OK** button to log in to the device.



- In the Login dialog box, if you enter the wrong password 7 times for admin user or 5 times for operators, the current user account will be locked for 30 minutes.
- If you select Remember Password, the system will remember the password for the current user without remembering the previous one.

Remote Login (via Web browser)

This section applies to DS-1200 KI keyboards.

Step 1 On the keyboard, enter the network settings menu.

System > Network

Step 2 Use the joystick to set the DHCP **OFF** or **ON**.

If you set the DHCP to ON, the system automatically obtains a network address.

If you set the DHCP to OFF, continue to set the network parameters, including the IP Address, Gateway and Subnet Mask.

Step 3 Press **OK** to save the settings.

Step 4 Open the Web browser, and enter the address (**https://IP address**) to enter the device login page.

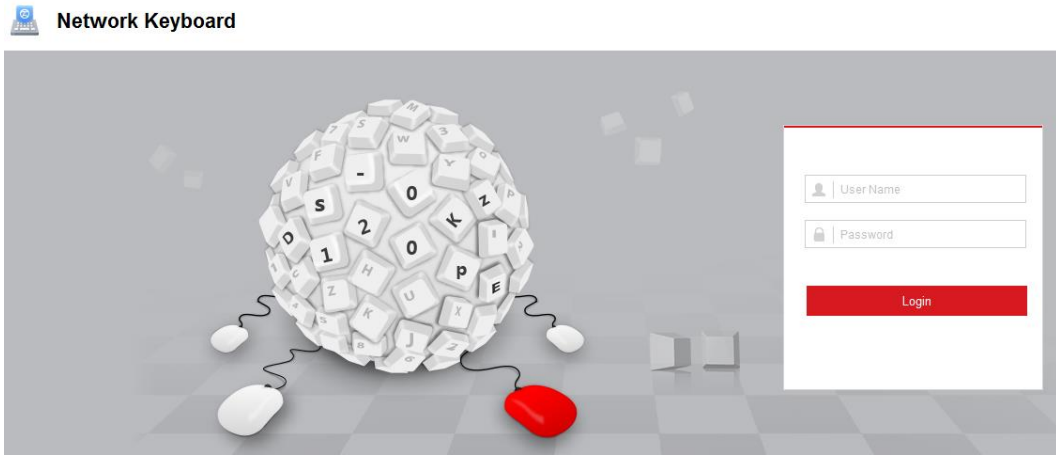

Figure 2-3 Login Interface

Step 5 Enter the user name and password in the field.

Step 6 Click **Login** to log in to the device.

2.3 System Menu

This section uses the DS-1200KI keyboard as an example to show the system menu items.

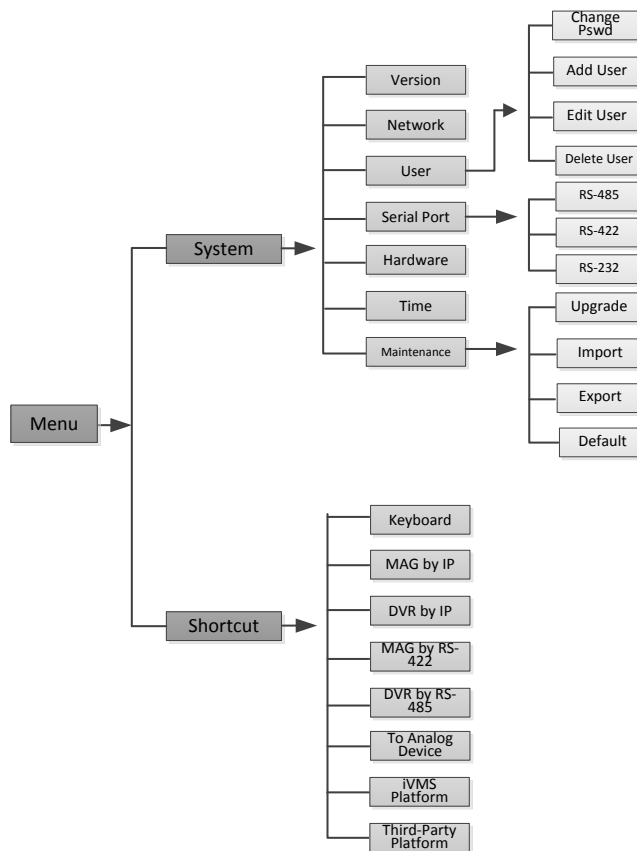

Figure 2-4 DS-1200KI System Menu

Chapter 3 Web Configuration

This section applies to DS-1200KI keyboards only.

3.1 Device Management

3.1.1 Add Devices

Purpose:

In Keyboard Operation mode, follow instructions in this section to add devices first before realizing the operation and control of the devices on the keyboard.

You are recommended to back up and edit the channel list using an Excel file. For adding devices for the first time, add a couple of devices first and then export it as a template. For details, see section 3.1.2 Manage Input/Output Channels.

Step 1 Log in to the device.

Step 2 Select **Device Management > Device List**.

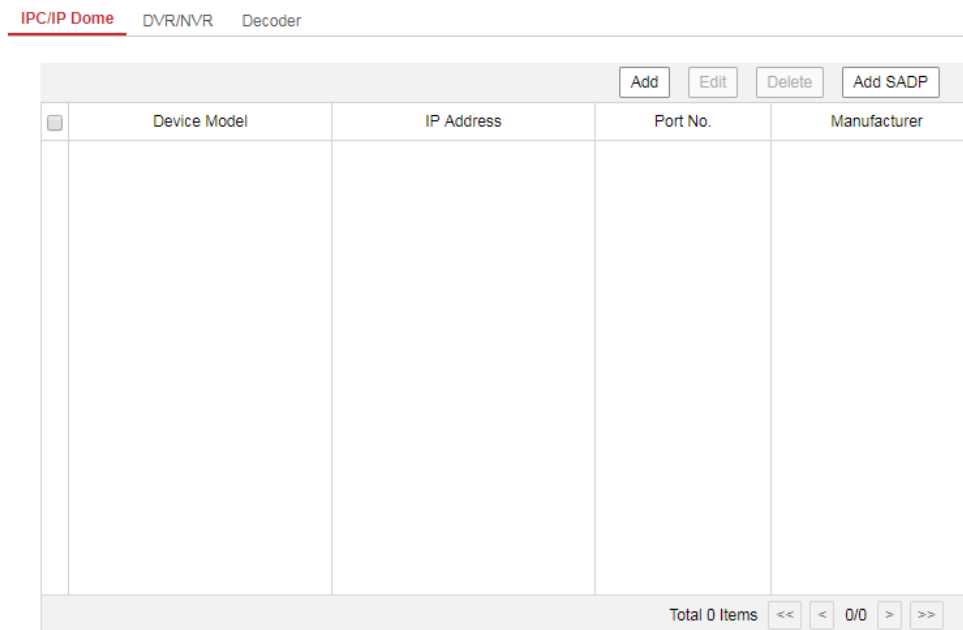

Figure 3-1 Device Management Interface

Step 3 Select a device type (IPC/IP Dome, DVR/NVR or Decoder) and click **Add** to add the devices.

Figure 3-2 Add Device

Step 4 You can add the device by IP or by IP segment. Enter the network parameters, including the IP address, port, login user name and password.

Step 5 Click **OK** to save the settings. The successfully added device is shown in the list.

IPC/IP Dome DVR/NVR Decoder

	Device Model	IP Address	Port No.	Manufacturer
<input type="checkbox"/>	IPC	192.168.0.1	80	ONVIF

Buttons: Add, Edit, Delete, Add SADP

Figure 3-3 Successfully Added Device

NOTE

You can also click the **Add SADP** to add the online devices in the same network segment.

3.1.2 Manage Input/Output Channels

Purpose:

You can manage the import and export of input channels in batch, input group and output channels via Web browser.

Import and Export Input Channel List

Step 1 Enter the **Device Management > Input Channel > Input List** page.

Input List							
Input Group							
<input type="button" value="Import"/> <input type="button" value="Export"/>							
							<input type="button" value="Edit"/>
ID	Camera Name	Chan No.	Device Model	IP Address	Port No.	Stream Type	transProtocol
1	Slot 02 Camera 01	1	DS-6508HW-B20B	10.65.64.152	20900	Main Stream	TCP
2	Slot 02 Camera 02	2	DS-6508HW-B20B	10.65.64.152	20900	Main Stream	TCP
3	Slot 02 Camera 03	3	DS-6508HW-B20B	10.65.64.152	20900	Main Stream	TCP
4	Slot 02 Camera 04	4	DS-6508HW-B20B	10.65.64.152	20900	Main Stream	TCP
5	Slot 02 Camera 05	5	DS-6508HW-B20B	10.65.64.152	20900	Main Stream	TCP
6	Slot 02 Camera 06	6	DS-6508HW-B20B	10.65.64.152	20900	Main Stream	TCP
7	Slot 02 Camera 07	7	DS-6508HW-B20B	10.65.64.152	20900	Main Stream	TCP
8	Slot 02 Camera 08	8	DS-6508HW-B20B	10.65.64.152	20900	Main Stream	TCP
9	Slot 02 Camera 09	1	DS-6508HW-B20B	10.65.64.152	21600	Main Stream	TCP
10	Slot 02 Camera 10	2	DS-6508HW-B20B	10.65.64.152	21600	Main Stream	TCP
11	Slot 02 Camera 11	3	DS-6508HW-B20B	10.65.64.152	21600	Main Stream	TCP
12	Slot 02 Camera 12	4	DS-6508HW-B20B	10.65.64.152	21600	Main Stream	TCP

Total 157 Items << < 1/14 > >>

Figure 3-4 Import & Export of Input List

Step 2 (optional) You can select an input channel from the list and click **Edit** to edit the parameters including the input channel ID, camera name, stream type and protocol type.

Step 3 Click the **Export** button to export the input channel list (in excel) to the local directory.

Click the **Import** button to import the input channel list (in excel) from the local directory.

Add Auto-Switch Groups

Step 1 Enter the **Device Management > Input Channel > Input Group** page.

Step 2 Click **Add Group** to enter the Add Input Group page.

Step 3 Edit the group name, set the auto-switch interval (10–10000 sec) and select the input channels from the list to the group.

NOTE

Up to 16 input groups can be added, and up to 64 input channels can be added for each group.

Input List **Input Group**

Group ID: 1 Name Auto-Switch: 20s

ID	Camera Name	Chan No.	Device Model	IP Address	Port No.	Stream Type
1	IPdome	1	DS-6416HD-T	10.65.199.176	8000	Main Strea
2	Camera 01	1	IPDOME_MEGA200	10.16.6.126	8000	Main Strea
3	Camera 02	2	IPDOME_MEGA200	10.16.6.126	8000	Main Strea
4	Camera 03	3	IPDOME_MEGA200	10.16.6.126	8000	Main Strea
5	Camera 04	4	IPDOME_MEGA200	10.16.6.126	8000	Main Strea
6	Camera 05	5	IPDOME_MEGA200	10.16.6.126	8000	Main Strea
7	Camera 06	6	IPDOME_MEGA200	10.16.6.126	8000	Main Strea
8	Camera 07	7	IPDOME_MEGA200	10.16.6.126	8000	Main Strea
9	Camera 08	8	IPDOME_MEGA200	10.16.6.126	8000	Main Strea
10	Camera 09	9	IPDOME_MEGA200	10.16.6.126	8000	Main Strea
11	Camera 10	10	IPDOME_MEGA200	10.16.6.126	8000	Main Strea
12	Camera 11	11	IPDOME_MEGA200	10.16.6.126	8000	Main Strea

Total 21 Items << < 1/1 > >>

Figure 3-5 Manage Input Group

Step 4 You can modify the group information or delete the group by **Modify Group** and **Delete Group** access.

Manage Output Channel

Step 1 Enter the **Device Management > Output Channel** page.

Step 2 You can check the output channel information, or select an output channel from the list and edit the channel ID.

3.2 User and User-related Device Management

The default user account of the device is admin (administrator), and the password is set when you start the device for the first time. The admin user account has the permission to add and delete operator accounts and configure user parameters, and add the related devices for the added users.

You can configure 1 administrator and 15 operator accounts.

Step 1 On the **System Management > User Management** web page, click **Add** to enter the adding user interface.

Add User
✕

User Name ✔

User Type

Password ✔

Strong

8 characters allowed, and you can use a combination of numbers, lowercase and uppercase letters for your password with at least two kinds of them contained.

Confirm Password ✔

Select Linked Device
Select All

<input checked="" type="checkbox"/>	ID	Device Type	IP Address	Port No.	Device Model
<input checked="" type="checkbox"/>	1	IPC/IP Dome	10.16.6.126	8000	IPDOME_MEGA200
<input checked="" type="checkbox"/>	2	DVR/NVR	10.16.5.17	8000	DS-9016HUHI-F8/N
<input checked="" type="checkbox"/>	3	Decoder	10.12.1.249	8000	DS-6408HD-T
<input type="checkbox"/>					

Selected 3 Total 3 Items
<< < 1/1 > >>

OK
Cancel

Figure 3-6 Add User

Step 2 Edit the user name, enter password (strong password is highly recommended), and confirm the password.

WARNING

STRONG PASSWORD RECOMMENDED—We highly recommend that you create a strong password of your own choosing (using a minimum of 8 characters, including upper case letters, lower case letters, numbers, and special characters) in order to increase the security of your product. And we recommend that you reset your password regularly, especially in the high security system, resetting the password monthly or weekly can better protect your product.

Step 3 Select the linked device (s) from the list for the user.

Step 4 Click **OK** to save the settings.

Chapter 4 Keyboard Operation

This section describes how to control devices using the keyboard.

On the keyboard, Press the MODE button on the panel to enter the operation for different devices. DS-1200KI keyboards support the following eight operation modes, while DS-1006KI keyboards support mode 4, 5, and 6.

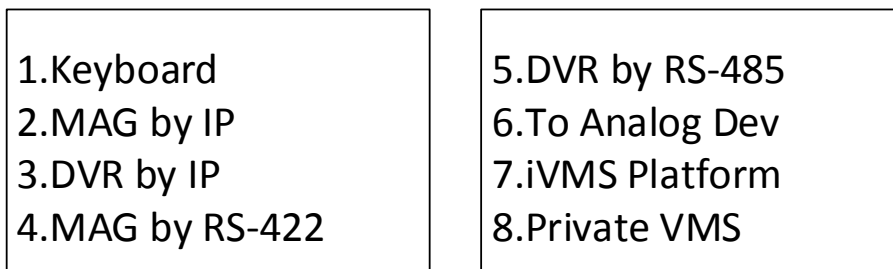

Figure 4-1 Operation Mode Selection

See the following table for the description of each keyboard mode.

Table 4-1 Description of Keyboard Mode

SN	Operation Mode	Description
1	Keyboard	The keyboard can be used for managing the devices (including the IPC, IP dome, DVR/NVR, MVC, decoder, video wall controller, etc.) for control. The keyboard can add the devices via Web browser and assign each of them the unique device ID, and finally manage to communicate with and realize the video wall or PTZ control through the <i>device ID+command</i> operation.
2	MAG by IP	The keyboard can connect with the matrix access gateway, and realize the video wall control, PTZ control, etc.
3	DVR by IP	The keyboard can connect with the DVR/NVR and remotely call the device menu and realize PTZ control through the virtual panel.
4	MAG by RS-422	The keyboard can connect with the matrix access gateway via RS-422 serial port, and realize the video wall control, PTZ control, etc.
5	DVR by RS-485	The keyboard can connect with the DVR/NVR via RS-485 serial port, and remotely call the device menu and realize PTZ control through the virtual panel.
6	To Analog Dev	The keyboard can connect with the analog dome or PTZ unit via RS-485 serial port, and realize PTZ control; or connect to analog

SN	Operation Mode	Description
		matrix via RS-232 port.
7	iVMS Platform	Use the keyboard as terminal to connect to the iVMS Platform and perform video wall and PTZ control.
8	Private VMS	Use the keyboard as terminal to connect to a third-party platform and support video operations through the platform.

4.1 Keyboard Operation

The keyboard can be used for managing the devices (including the IPC, IP dome, DVR/NVR, MVC, decoder, video wall controller, etc.) for control.

4.1.1 Video Wall Control

Purpose:

You can select different window-division display modes for the selected output channel. The configurable multi-division display modes depend on the decoders, video wall controller, or MVCs.



The 1/2/4/6/8/9/12/16/25/32/36 window-division display modes are configurable.

Step 1 In the **Keyboard** operation mode, press the *Num + DEV* buttons on the keyboard panel to select the device ID (decoder, MVC and video wall controller).

Step 2 (Optional): Press the *Num + Video Wall* buttons to select the video wall or joint screen.

Step 3 Press the *Num + MON* buttons to select the display window for the output channel.

Step 4 (Optional) Press the *Num + MULT* buttons to set the window-division display mode for the output channel.

Step 5 Press the *Num + WIN* buttons to set the sub-window to play the decoded video. The selected sub-window ID is shown in [ID] on the interface, e.g., [02].

Step 6 Press the *Num + CAM/CAM-G* buttons to select the input channel or input channel group. You can press the PREV/NEXT buttons to switch to the previous or next camera / camera group ID.

DEV: 2	WALL: 1	DEV: 5	WALL: 1
MON: 2	[02]	MON: 2	[02]
CAM: 6		CAMG: 4	

Figure 4-2 Video Wall Operation

 **NOTE**

- When you enter no device ID (DEV), the first decoder found is set for control by default. And if you enter no WIN ID, the window 01 is set to play the decoded video by default.
- To directly operate the PTZ control, press the *Num + CAM* buttons. Press the *0 + CAM* buttons to stop decoding of the current camera, or press the *0 + CAM-G* buttons to stop cycle decoding of the camera group.
- To control the local decoding channels of NVRs/DVRs, firstly go to the Web interface of the NVRs/DVRs and view the input channel IDs, and then press *Num + CAM* buttons to control the channels.
- For DS-96000 series NVRs, if a decoding card is used for decoding output, you need to firstly drag the output channel to the corresponding display window on the video wall using a client software. Then press *Num + DEV + Num + WIN + Num + CAM/CAM-G* to control the camera without pressing the MON ID.

Step 7 Operate the PTZ control on the video wall.

Move the joystick to realize pan/tilt movement in 8 directions and zoom in/out control.

Rotate the joystick in clockwise/anti-clockwise directions to I to realize the zoom in/out control.

The central button of the joystick can be used to capture picture.

4.1.2 Call Presets/Patrols/Patterns

The keyboard can be used to control the PTZ function of the connected IP dome camera, including the pan/tilt movement, zoom/iris/focus adjustment, and preset/patrol/pattern calling.

Step 1 In the **Keyboard** operation mode, press the *Num + MON* buttons to select the output channel ID.

Step 2 Press the *Num + WIN* buttons to set the sub-window to play the decoded video.

Step 3 Press the *Num + CAM* buttons to select the input channel for PTZ control.

Step 4 Call the preset/patrol/pattern.

- Press the *Num + PRESET* buttons on the keyboard panel to call the defined preset.
- Press the *Num + PATROL* buttons on the keyboard panel to call the defined patrol.
- Press the *Num + PATTERN* buttons on the keyboard panel to call the defined pattern.

DEV: 2	WALL: 1
MON: 2	[02]
CAM: 6	
PRESET: 1	

Figure 4-3 Preset Calling

 **NOTE**

- The preset/patrol/pattern must be pre-configured.
- Whether PTZ functions are available or not depends on the capabilities of speed domes. If the speed domes do not support a PTZ function, the keyboard does not respond.

4.1.3 Call Scenes

Purpose:

For the MVC, video wall controller, and decoder added to the keyboard, you can configure the scene via the client software first and follow the steps below to switch the scene.

Step 1 In the **Keyboard** operation mode, press the *Num + DEV* buttons on the keyboard panel to select the device ID (decoder, MVC and video wall controller).

Step 2 Press the *Num + SCENE* buttons on the keyboard panel to switch to the defined scene.

 **NOTE**

The scene of the video wall must be pre-configured for the decoder or MVC via client software.

WALL: 1
DEV: 1
SCENE: 2

Figure 4-4 Scene Calling

4.2 MAG by IP

The keyboard can connect with the matrix access gateway, and realize the video wall control, PTZ control, etc.

Step 1 Log in to the keyboard via Web browser (*https://ip address*), and enter the Matrix Access Gateway Settings page.

Matrix Access Gateway

IP Address	<input type="text" value="192.0.0.68"/>	✓
Port	<input type="text" value="8000"/>	✓
User Name	<input type="text" value="admin"/>	✓
Password	<input type="password" value="•••••"/>	✓

 Save

Figure 4-5 Matrix Access Gateway

Step 2 Configure the parameters of the matrix access gateway. And click **OK** to save the settings.

Step 3 Enter the **MAG by IP** operation mode on the keyboard.

Step 4 Press the *Num + MON* buttons to select the display window for the output channel.

Step 5 Press the *Num + WIN* buttons to set the window to play the decoded video.

Step 6 Press the *Num + CAM* buttons to select the input channel group. You can press the *PREV/NEXT* buttons to switch to the previous or next camera ID.

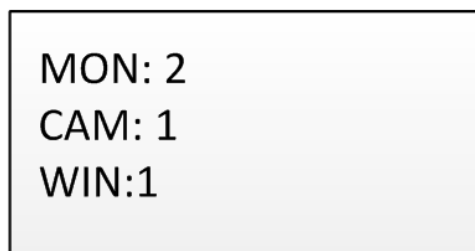

Figure 4-6 MAG by IP

 **NOTE**

For the initial use of MAG, you must use the configuration kits software to configure the input/output channel ID of the MAG. Please see the related user manual for details. The input/output channel ID is used for switching on the video wall or PTZ control during keyboard operation.

Step 7 Operate the PTZ control on the video wall.

4.3 DVR by IP

The keyboard can connect with the DVR/NVR and remotely call the device menu and realize PTZ control through the virtual panel.

Step 1 Log in to the keyboard via Web browser (*https://ip address*), and enter the DVR/NVR device list (**Device Management > Device List > DVR/NVR**).

Step 2 Click **Add** to add the DVR/NVR device.

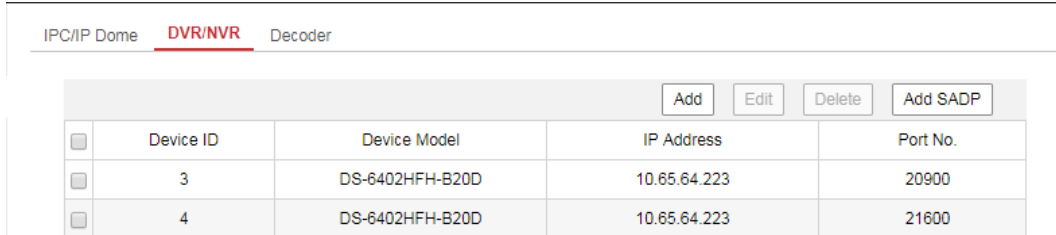

	Device ID	Device Model	IP Address	Port No.
<input type="checkbox"/>	3	DS-6402HFH-B20D	10.65.64.223	20900
<input type="checkbox"/>	4	DS-6402HFH-B20D	10.65.64.223	21600

Figure 4-7 DVR/NVR Management

Step 3 Enter the **DVR by IP** operation mode on the keyboard.

Step 4 Press the *Num + DEV* buttons on the keyboard panel to select the device ID (viewed on the **Device Management > Device List > DVR/NVR**).

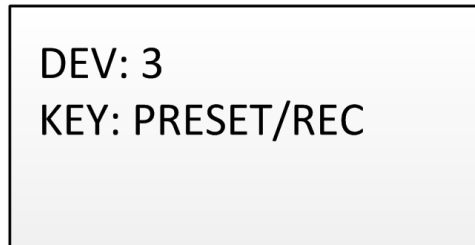

Figure 4-8 DVR by IP

Step 5 Operate the buttons on the keyboard panel to realize the corresponding functions. See section 1.5 Functional Buttons to check the description of the DVR/NVR control buttons.

4.4 MAG by RS-422

The keyboard can connect with the matrix access gateway via RS-422 serial port, and realize the video wall control, PTZ control, etc.

Before you start:

Check the connection between the MAG and the Keyboard. Connect the **T+** and **T-** terminals of the keyboard's RS-422 serial port with the MAG's RS-422 serial port.

See the following figure:

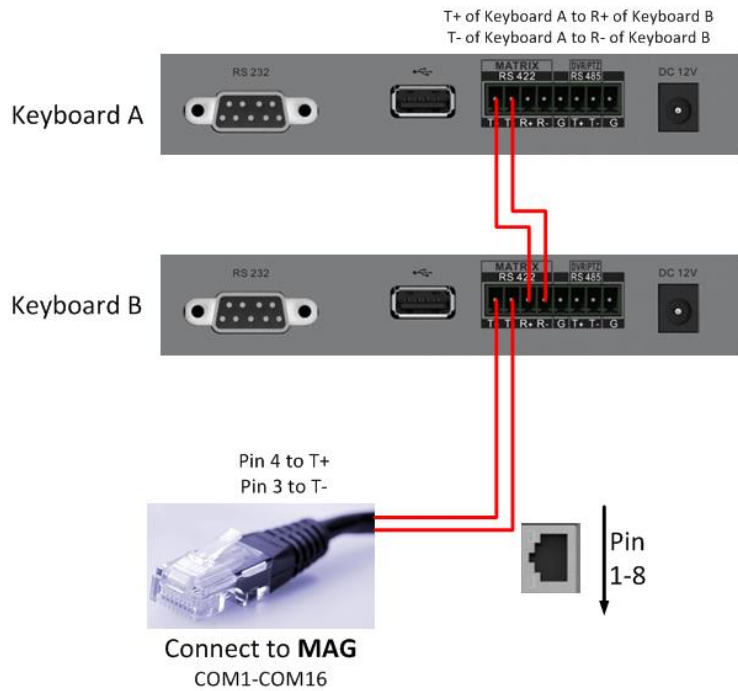

Figure 4-9 Connection between Cascaded Keyboards and MAG

See the following figure as an example for the network cable (568B). The pin 3 and pin 4 are colored in green-white and blue.

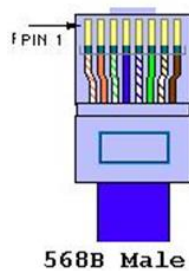

Figure 4-10 Network Cable

- Step 1 Enter the **MAG by RS-422** operation mode on the keyboard.
- Step 2 Press the *Num + MON* buttons to select the display window for the output channel.
- Step 3 Press the *Num + WIN* buttons to set the window to play the decoded video.
- Step 4 Press the *Num + CAM* buttons to select the input channel.

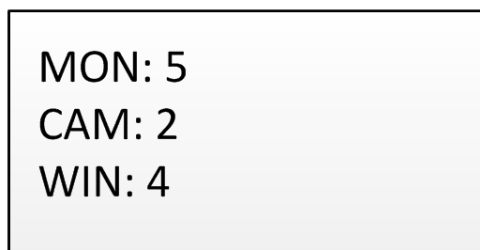

Figure 4-11 Matrix Operation

Step 5 You can operate the PTZ control on the video wall for the connected dome.

 **NOTE**

- You can also press the *Num* + *CAM* buttons to select the input channel, and operate the PTZ control.
- For the initial use of *MAG*, you must use the configuration kits software to configure the input/output channel ID of the *MAG*. Please see the related user manual for details. The input/output channel ID is used for switching on the video wall or PTZ control during keyboard operation.

4.5 DVR by RS-485

 **WARNING**

In DVR by RS-485 mode, the keyboard screen will display a prompt message asking you to confirm your device version. If your NVR is of a 4.1.50 or later version, select **Yes**; otherwise, select **No**. If your DVR is of a 3.5.35 or later version, select **Yes**; otherwise, select **No**. Please note that selecting an incorrect device version may result in function unavailability.

If you encounter a camera control problem, try to change the device ID of your NVR or DVR to a digit from 1 to 16.

The keyboard can connect with the DVR/NVR via RS-485 serial port, and remotely call the device menu and realize PTZ control through the virtual panel.

Before you start:

Check the connection between the DVR/NVR and the Keyboard. Connect the **T+** and **T-** terminals of the keyboard's RS-485 serial port with the KB port on the DVR/NVR rear panel respectively.

 **NOTE**

Our keyboard products support DVR/NVR with KB ports only.



Figure 4-12 RS-485 Serial Port

Step 1 Enter the **DVR by RS-485** operation mode on the keyboard.

Step 2 Press the *Num + DEV* buttons on the keyboard panel to select the device ID (corresponding to the remote ID on ClientDemo).

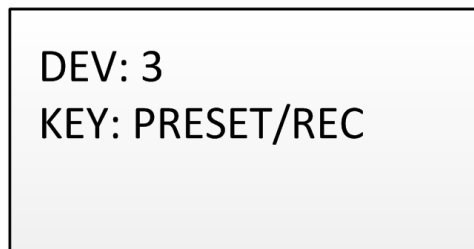

Figure 4-13 DVR by RS-485

Step 3 Move the joystick and operate the buttons on the keyboard panel to realize the corresponding functions. See section 1.5 Functional Buttons to check the description of the DVR control buttons.

NOTE

The baud rate, protocol and other parameters of RS-485 of the keyboard must be configured to 9600, 8, 1 and none parity.

4.6 To Analog Device

4.6.1 Dome by RS-485

The keyboard can connect with the analog dome or PTZ unit via RS-485 serial port, and realize PTZ control.

Before you start:

Check the connection between the dome and the Keyboard. Connect the **T+** and **T-** terminals of the keyboard's RS-485 serial port with the **RS485+** and **RS485-** terminals of the dome respectively.

Step 1 Enter the **To Analog Dev** operation mode on the keyboard.

Step 2 Press the *Num + CAM* buttons to select the dome site.

Step 3 Use the joystick and operate the buttons on the keyboard panel to realize the corresponding functions.

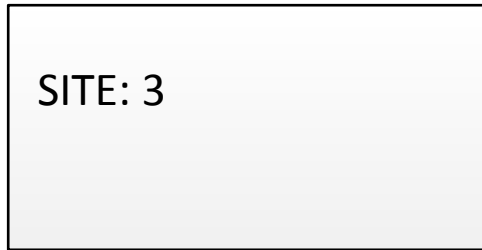

Figure 4-14 Dome by RS-485

 **NOTE**

The address, baud rate, protocol and other parameters of RS-485 must be configured the same with the dome's RS-485 parameters.

4.6.2 Analog Matrix by RS-232

Step 1 Connect analog matrix to the RS-232 interface of the keyboard using RS-232 cable as shown below.



Figure 4-15 Analog Matrix RS-485 Connection

Step 2 Log in to the keyboard, select **Mode > To Analog Dev** and enter *Num + DEV*, *Num + MON* and *Num + CAM* to select the camera to control.

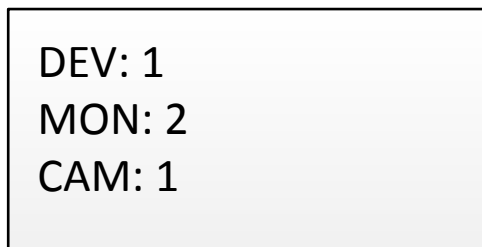

Figure 4-16 Analog Matrix By RS-485

4.7 iVMS and Third-Party Platform

4.7.1 Access iVMS Platform by Network

Step 1 Log in to the keyboard through Web, select **Platform Access > iVMS Keyboard Proxy** and configure parameters for the iVMS server.

iVMS Keyboard Proxy	Third-Party Platform
IP Address	10.65.199.201
Port	8000
User Name	admin
Password	*****

Figure 4-17 iVMS Platform Access

Step 2 Log in to iVMS platform, view the MON ID and CAM ID.

Step 3 Log in to the keyboard, select **Mode > iVMS Platform** and enter *Num + WALL*, *Num + MON* and *Num + CAM*, or directly *Num + CAM* to select the camera to control.

WALL: 2
MON: 2
CAM: 6

Figure 4-18 iVMS Platform Settings

NOTE

- The parameters configurable through Web are also available when you log in to the keyboard and select **Mode > iVMS Platform**.
- Log in to the iVMS platform to check which device is corresponding to the number entered for MON and CAM. For details about the operations, see the related iVMS platform operation manual.

4.7.2 Access Third-Party Platform by Network

Step 1 Log in to the keyboard through Web, select **Platform Access > Third-Party Platform** and configure parameters for the third-party platform server.

iVMS Keyboard Proxy **Third-Party Platform**

IP Address

Port

 Save

Figure 4-19 Third-Party Platform Access

Step 2 Log in to the keyboard, select **Mode > Private VMS** and enter *Num + MON*, *Num + WIN* and *Num + CAM* to select the camera to control.

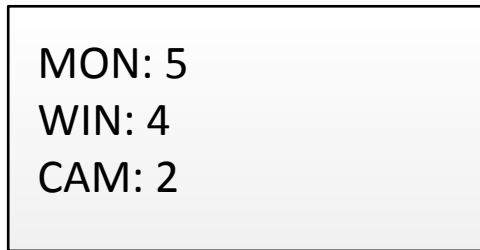

Figure 4-20 Private VMS Settings

 **NOTE**

The parameters configurable through Web are also available when you log in to the keyboard and select **Mode > Private VMS**.

4.8 Shortcut Operation

The device control via keyboard can be realized by shortcut operation.

Step 1 On the login interface, enter the user name and password to log in to the device.

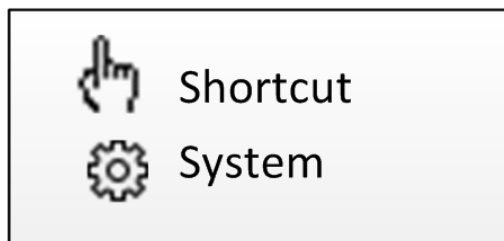

Figure 4-21 Menu

Step 2 Use the joystick to select the **Shortcut** to enter the shortcut operation mode.

Step 3 Press the *Num + DEV/MON/CAM/CAM-G/PRESET/PATROL/PATTERN/WIN/MULT/SCENE* on the keyboard buttons to realize the corresponding device operation and control.

Chapter 5 System Menu Configuration

On the main menu after login, you can select **System** to check the version, and configure the system configuration, including network, user, RS-485, RS-422, hardware, time and maintenance.

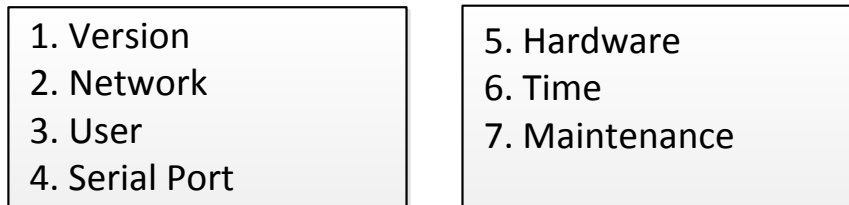

Figure 5-1 Main Menu

5.1 Version

Select **Version** to check the version information of the keyboard, including the firmware, panel, hardware and software version.

5.2 User Management

Select **User** to enter the user management interface. You can change the password (admin), add new user, edit user or delete the user.

Click **OK** button or the central button of joystick to save the settings.

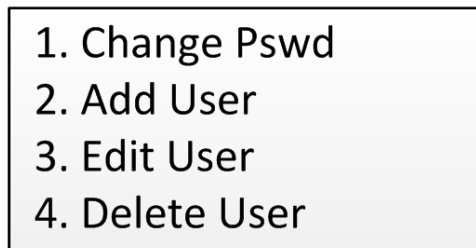

Figure 5-2 User Management



Only the admin user is allowed to add/edit/user the user (operator).

5.3 Serial Port Settings

You can connect analog dome or DVR with the keyboard via RS-484 serial port, MVC/MAG via RS-422 serial port and analog matrix via RS-232 serial port.

Select **Serial Port** to enter the settings. You can configure the address bit (RS-485 only), baud rate, data bit, protocol, stop bit, parity, and copy all settings. When you set the Copy All to Yes for RS-485 serial port, the current settings will be copied to the connection of all other RS-485 devices.

Click the **OK** button or the central button of joystick to save the settings.



Figure 5-3 RS-485 Settings

NOTE

The RS-485/RS-422 parameters configured here must be the same with the connected dome/DVR or MAG.

5.4 Hardware

You can set the auto-logoff and backlight feature of the keyboard.

Select **Hardware** to enter the following interface, and move (left/right) the joystick to set the function of **A-Logoff** and **Backlight** as needed. Click **OK** button or the central button of joystick to save the settings.

When the auto-logoff is set to ON, the system will automatically log off after the device is not operated for 30 minutes; the duration of backlight can be set as **Open** (always turned on), **5min**, **10min**, **30min** and **60min**.

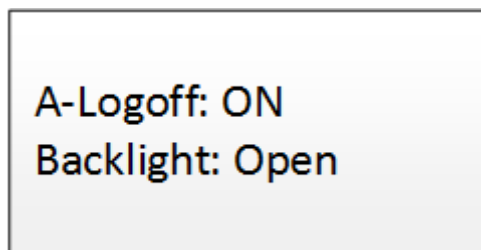

Figure 5-4 Hardware Settings

5.5 Time Settings

Select **Time** to enter the system time settings interface. You can set the value of year, month, date, time format, hour, minute and second. Click **OK** button or the central button of joystick to save the settings.

5.6 Maintenance

Select **Maintenance** to enter the system maintenance settings interface. You can upgrade the device, import and export the configuration files, and recover the device to the factory default settings.



Figure 5-5 Maintenance

 **NOTE**

- You should connect the U-flash disk to the keyboard before upgrading, and importing/exporting the files.
- The upgrade file and configuration file must be located in the root directory of the U-flash disk.
- The upgrade file must be in *digicap.dav*; and the configuration file in *kbCfg.bin*.

Chapter 6 Specifications

Table 6-1 Specification of DS-1200KI

Model		DS-1200KI
System	LCD screen	128 × 64 pixel screen
	Joystick	4-axis joystick
	Control mode	Network, RS-232, RS-422, RS-485
External Interfaces	Network interface	1 × 10/100 Mbps self-adaptive Ethernet interface
	Serial interface	1 × RS-232, 1 × RS-422, 1 × RS-485
	USB interface	1 × USB 2.0
General	Power supply	12 VDC
	Consumption	≤ 4.5 W
	Working temperature	−10 to 55° C (14 to 131° F)
	Working humidity	10% to 90%
	Dimensions (W × D × H)	435 × 193 × 110 mm (17.1 × 7.6 × 4.3 inch)
	Weight	≤ 1 kg (2.2 lb)

Table 6-2 Specification of DS-1006KI

Model		DS-1006KI
System	LCD screen	128 × 64 pixel screen
	Joystick	4-axis joystick
	Control mode	RS-232, RS-422, RS-485
External Interfaces	Serial interface	1 × RS-232, 1 × RS-422, 1 × RS-485
	USB interface	1 × USB 2.0
General	Power supply	12 VDC
	Consumption	≤ 4.5 W
	Working temperature	−10 to 55° C (14 to 131° F)
	Working humidity	10% to 90%
	Dimensions (W × D × H)	435 × 193 × 110 mm (17.1 × 7.6 × 4.3 inch)
	Weight	≤ 1 kg (2.2 lb)

0102001080907

